

HOJA DE INSTRUCCIONES / INSTRUCTION LEAFLET / INSTRUCTIONS. SERIE ARA LED / ARA LED SERIE / SÉRIE ARA LED

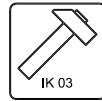

MADE IN SPAIN

CONEXIÓN - CONNECTION - CONNEXION

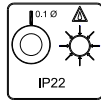
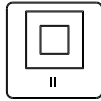
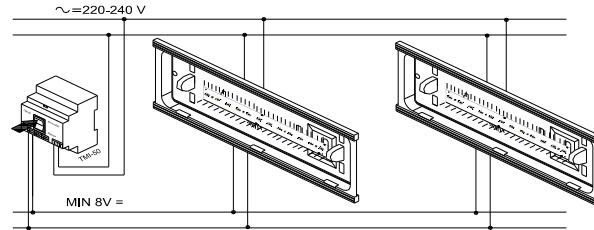
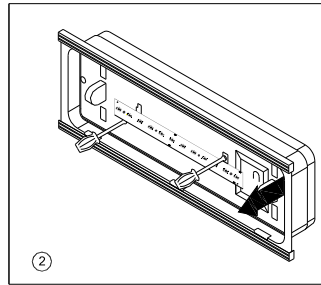
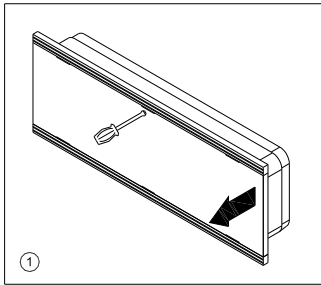

OK

Test de verificación.
Verification test.
Test de vérification.

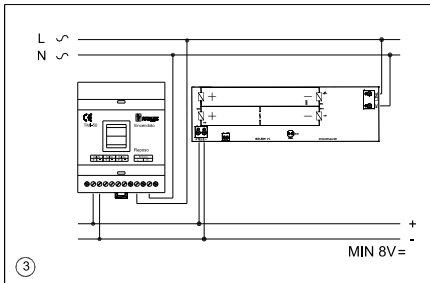

N.P. - No permanente con puesta en reposo.
N.P. - Non maintained with standby.
N.P. - Non permanent avec mise en veille.

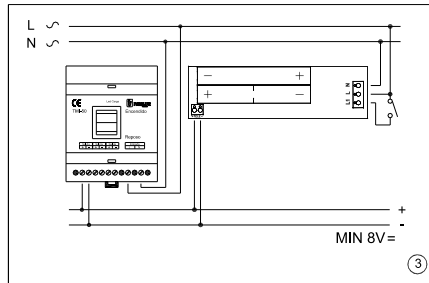

P. - Permanente con puesta en reposo.
P. - Maintained with standby.
P. - Permanent avec mise en veille.

Empotrar en techo. - Ceiling flush in. - Encastrer au plafond.

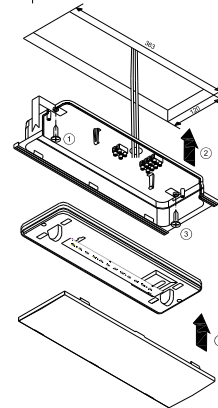
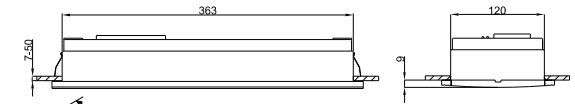

- 1.- Atornillar primera chapa. - Screw first clip. - Visser la 1ère plaque.
- 2.- Colocar la base en el hueco. - Place the base in the hole. - Placer la base dans le trou.
- 3.- Atornillar la segunda chapa. - Screw second clip. - Visser la seconde plaque.
- 4.- Montar el equipo. - Assemble luminaire. - Assembler l'appareil.

MANTENIMIENTO - MAINTENANCE

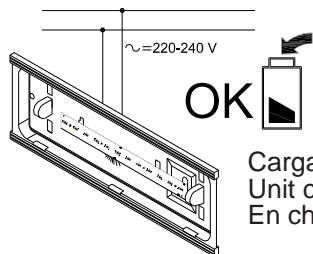

Cargando y batería en buen estado.
Unit charging and battery OK.
En charge et batterie en bon fonctionnement.

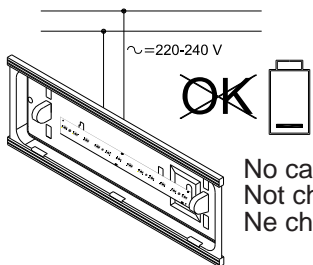

No carga. Verificar / Reponer.
Not charging. Check / Replace.
Ne charge pas. Vérifier / Remplacer.

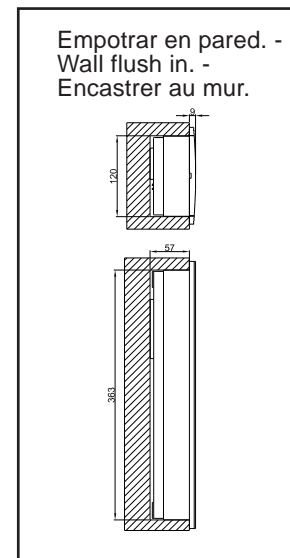
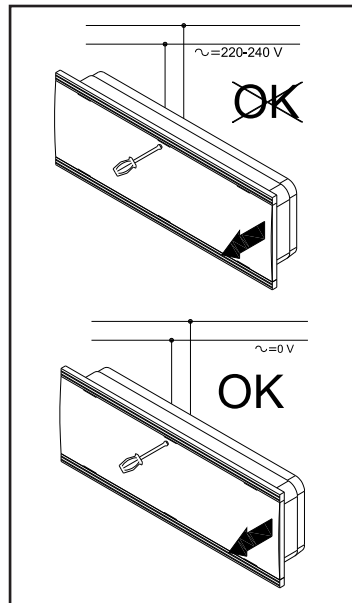
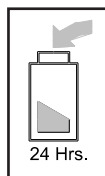

Si la autonomía de la luminaria es inferior a la asignada, hay que sustituir la luminaria.
If luminaire does not reach the rate operating life, then the luminaire has to be replaced.
Si l'autonomie du luminaire est inférieure à celle assignée, le luminaire doit être changé.

2 años de garantía conforme a la ley 23/2003 de 10 de julio. 2 years guarantee according to law 23/2003 of July 10th. Garantie 2 ans conformément à la loi 23/2003 du 10 juillet.