

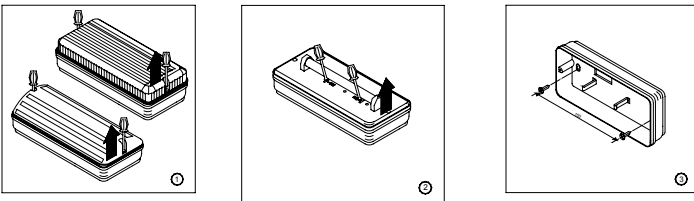

CURVAS FOTOMÉTRICAS DISPONIBLES – PHOTOMETRIC CURVE GRAPHS AVAILABLE ON REQUEST - COURBES PHOTOMETRIQUES SUR DEMANDE - LICHTVERTEILUNGSKURVEN BEI BEDARF ERHÄLTICH - CURVAS FOTOMÉTRICAS DISPONÍVEIS A PEDIDO - CURVE FOTOMETRICHE DISPONIBILI A RICHIESTA - KŘIVKY SVĚTIVOSTI JSOU NA VYŽÁDÁNÍ K DISPOZICI tel. 545 197 213 - Фотометрические графики доступны по требованию

DOS AÑOS DE GARANTÍA CONFORME A LA LEY 23/2003 DE 10 DE JULIO.



N.P. → NO PERMANENTE CON PUESTA EN REPOSO
 N.P. → NON MAINTAINED WITH STANDBY
 N.P. → NON PERMANENT AVEC MISE AU REPOS
 N.P. → BEREITSCHAFTSSCHALTUNG MIT ABSCHALTUNG DER NOTLEUCHE
 N.P. → NÃO PERMANENTES COM COLOCAÇÃO EM REPOUSO
 N.P. → NON PERMANENTE CON MODALITA' DI RIPOSO
 N.P. → NETRVALÉ NOUZOVÉ SVĚTIDLO
 N.P. → в нормальном режиме с паузой

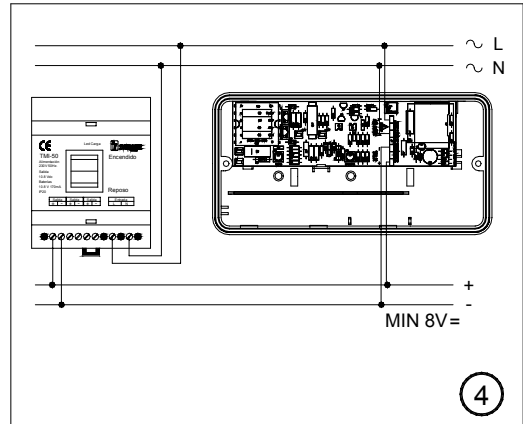

4

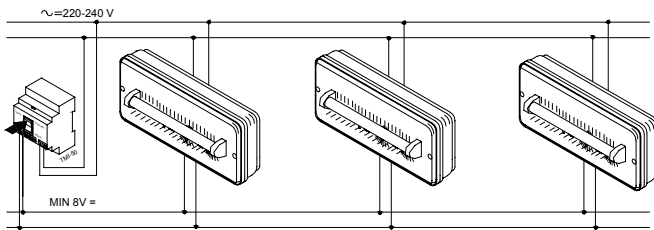

OK

TEST DE VERIFICACIÓN
 VERIFICATION TEST
 TEST DE VERIFICATION
 FUNKTIONSTEST
 TESTE DE VERIFICAÇÃO
 TEST DI VERIFICA
 TEST FUNKČNOSTI SVĚTIDLA
 TECT

MANTENIMIENTO – MAINTENANCE – ENTRETIEN – UNTERHALTUNG – MANUTENÇÃO – MANUTENZIONE - OVĚŘENÍ -
 Проверка

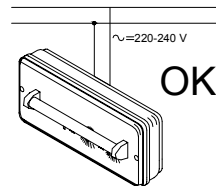

CARGANDO Y BATERÍA EN BUEN ESTADO
 UNIT CHARGING AND BATTERY OK
 EN CHARGE OU CHARGÉE
 WIRD GELADEN ODER IST GELADEN
 EM CARGA OU CARREGADA
 CARICA IN ATTO O ULTIMATA
 NABIJENI A STAV AKUMULÁTORU
 Идет нормальная зарядка батареек

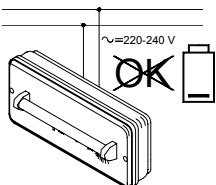

NO CARGA. VERIFICAR / REPONER
 NOT CHARGING. CHECK / REPLACE
 NE CHARGE PAS. VÉRIFIER / REMPLACER
 LÄDT NICH. ÜBERPRUFEN / ERSETZEN
 NÃO CARREGA. VERIFICAR / SUBSTITUIR
 NON CARICA. VERIFICARE / SOSTITUIRE
 NENABIJÍ, KONTROLA / VYMĚNA
 не заряжено/требуется замена

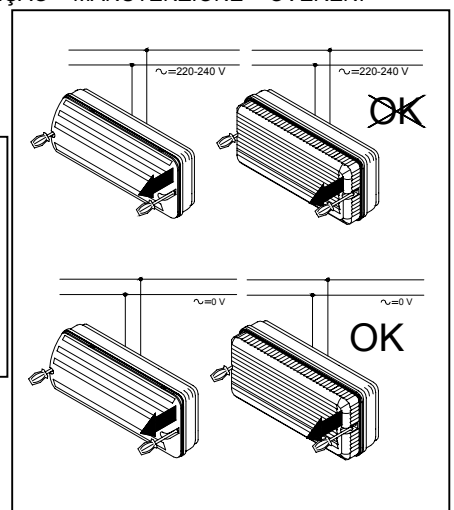
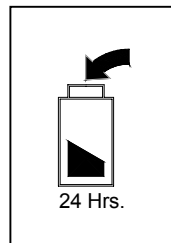

SI LA AUTONOMÍA DE LA LUMINARIA ES INFERIOR A LA ASIGNADA, HAY QUE SUSTITUIR LA BATERÍA
 IF LUMINAIRE DOES NOT REACH THE RATE OPERATING LIFE, THEN THE BATTERIES HAVE TO BE REPLACED
 LES ACCUMULATEURS DOIVENT ÊTRE REPLACÉS LORSQUE LE BLOC AUTONOME NE SATISFAIT PLUS À SA DUREE ASSIGNÉE DE FONCTIONNEMENT
 WENN DIE ANGELEGEBENE LEUCHTDAUER DER EINZELBATTERIE UNTERSCHRITTEN WIRD SIND DIE AKKUMULATOREN UNBEDINGT ZU TAUSCHEN
 SE A AUTONOMIA FÖR INFERIOR À ESTIPULADA; SUBSTITUIR OS ACUMULADORES
 QUANDO L'AUTONOMIA DELLA LAMPADA NON È PIU' QUELLA NOMINALE LA BATTERIA DEVE ESSERE SOSTITUITA.
 POKUD SVĚTIDLO NESVĚTÍ STANOVENOU DOBU V NOUZOVÉM REŽIMU, AKUMULÁTORY MUSÍ BYT VYMĚNĚNY
 в случае если прибор не работает на протяжении положенного времени, следует заменить батарею

REF	LAMP T1	IK-08	1,9 Nm
B 30L	TL – 4W	2,4V 1,5Ah	1
B 60L			
B 90L			
B 180L	PL – 9W	3,6V 1,5Ah	
B 200L			
C 40LP			
C 70LP			
C 180LP	PL – 9W	3,6V 1,5Ah	
C 220LP			
C 300LP			